



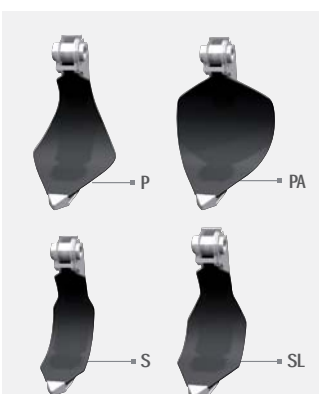
 Benna a polipo per movimentazione rottame e materiali vari
 Polyp-grab for scrap's and different materials' handling
 Grappin pour la manipulation de la ferraille et de matériaux divers

 Mehrschalengreifer für Schrott-und verschiedenen Materialumschlag
 Pulpos para chatarra y materiales diversos
 Полип – грейфер для погрузки металлолома и различных материалов

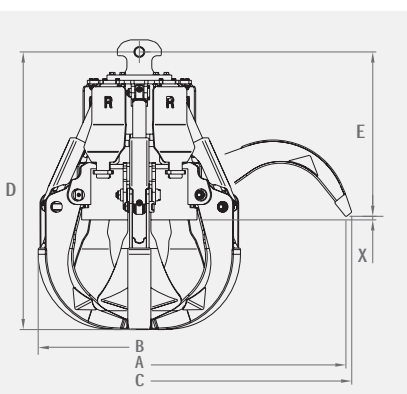
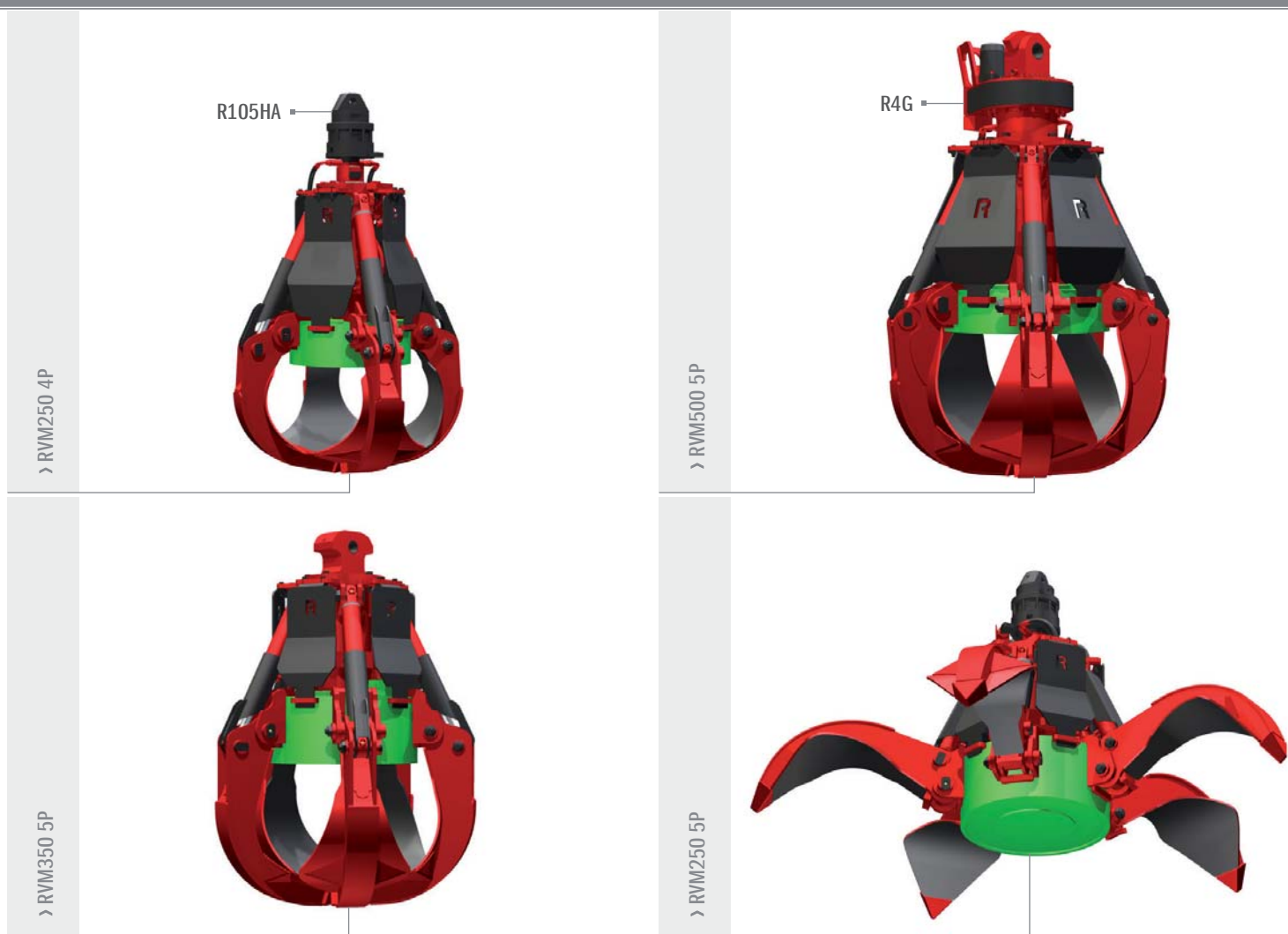

Modello	Diametro magnete	Potenza	Tensione
Model	Magnet diameter	Power	Voltage
Modèle	Diamètre de l'aimant	Puissance	Tension
Modell	Magnetdurchmesser	Leistung	Spannung
	mm	W	V DC
RVM250	550	600	24
RVM350	650	600/2000	24/220
RVM500	800	3650	220

Modello	Capacità	Peso	Denti n°	Pressione	Portata olio	Forza al dente	Dimensioni					
Model	Capacity	Weight	Teeth no.	Pressure	Oil flow	Tooth force	Sizes					
Modèle	Capacité	Poids	Dents n.	Pression	Débit d'huile	Puissance à la dent	Dimensions					
Modell	Inhalt	Gewicht	Zähne Stk.	Druck	Ölleistung	Schließkraft je Schale	Abmessungen					
	dm³	kg	n°	bar	l/min	Kg	A	B	C	D	E	X
RVM250 4P	250	650	4	300	70	1655	1575	1065	1745	1400	1285	35
RVM250 5P	250	700	5	300	90	1655	1575	1065	1745	1400	1285	35
RVM350 4P	350	940	4	300	80	1395	1900	1155	2115	1565	1410	20
RVM350 5P	350	1000	5	300	100	1395	1900	1155	2115	1565	1410	20
RVM500 4P	500	1350	4	300	130	1985	2770	1335	2835	1740	995	50
RVM500 5P	500	1530	5	300	160	1985	2770	1335	2835	1740	995	50